



FIMI A3 Drone User Manual

Please read the user manual carefully before using and keep the manual for future reference.

Services & Support

FIMI provides A3 users with instructional video and the following information:

1. User Manual
2. Quick Start Manual
3. Disclaimer and Safety Operation Instructions

Users are advised to watch instructional video before using the product and to carefully read the Disclaimer and Safety Operation Instructions, and get to know the process of using by going through the Quick Start Manual. For more product information, please refer to the User Manual. Please download the firmware and watch the instructional video through the link below www.a3.fimi.com

Product Introduction

A3 is a small multi-functional quadrotor aircraft with integrated aerodynamics, intelligent control, wireless communication and other advanced technologies, which can realize the functions of analog photo transmission, remote controller, HD aerial photography, intelligent flight, etc. It can play the FPV traversing outdoor freely, and can be connected with abundant DIY accessories. The three-axis hybrid stabilized gimbal camera equipped by the aircraft can take 1080p HD video steadily and preview the image in real time on the remote controller with a 4.3 inch display. The airframe is light and convenient to carry.

Package List

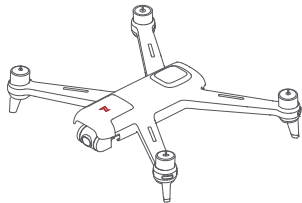

Aircraft x1

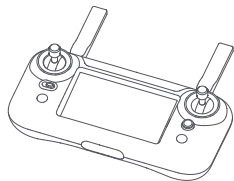

Remote controller x1

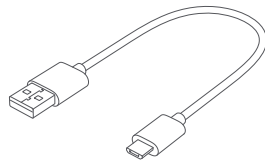

USB cable x1

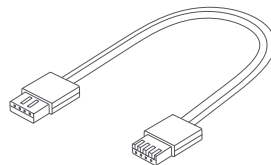

Charging transfer cable x1

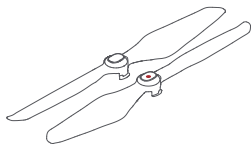

Positive propellers x3
Reverse propellers x3

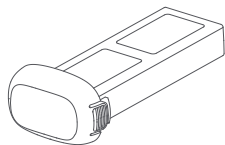

Battery x1

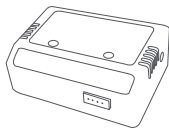

Balance charge x1

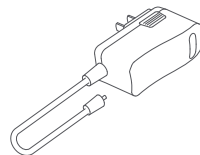

Charger x1



Instructions x2

Product Introduction

1 Aircraft

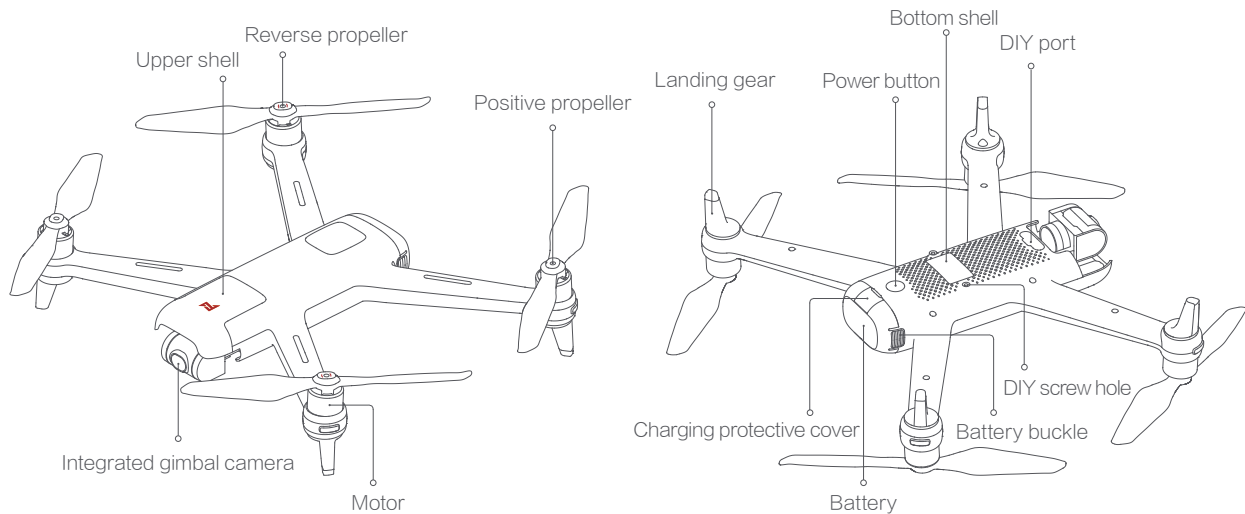

2.1 Remote controller

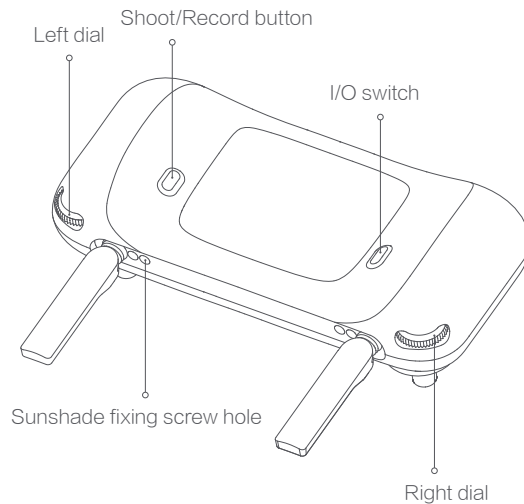
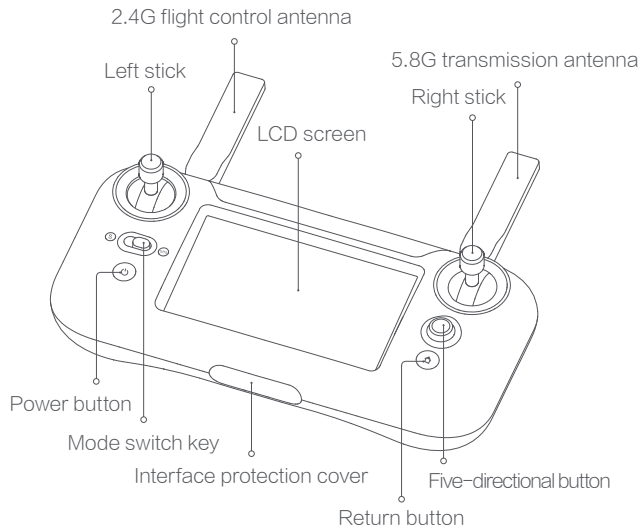

2.2 Buttons function introduction of RC

	Buttons	Function description	
1	Left stick	Push stick upward, the aircraft goes up; pull stick downward, the aircraft goes down; toggle stick to left, the aircraft rotates counter-clockwise; toggle stick to right, the aircraft rotates clockwise	
2	Right stick	Push stick upward, the aircraft flies forward; pull stick downward, the aircraft flies backward; toggle stick to left, the aircraft flies to left; toggle stick to right, the aircraft flies to right	
3	Mode switch key	Toggle to left to switch to sport mode, Toggle to right to switch to standard mode	
4	Return button	Long press more than 3 seconds can enter auto return / short press to exit auto return	
5	Power button	Long press to turn on/off	
6	I/O switch	I/O port control	
7	Five directional button	Up	Shortcut key: Smart Flight settings
		Down	Shortcut key: Camera parameter settings
		Left	1.Shortcut key: Enter the settings menu; 2. Return to the last level
		Right	Shortcut key: Enter media library
		Center	1.Shortcut key: Recording screen 2. Confirm operation
8	Left dial	Adjusting the pitch angle of gimbal	
9	Right dial	By default, EV values are adjusted and PWM is used to provide user DIY.	
10	Camera/Record button	Short press to take a picture; long press to start/ stop recording	

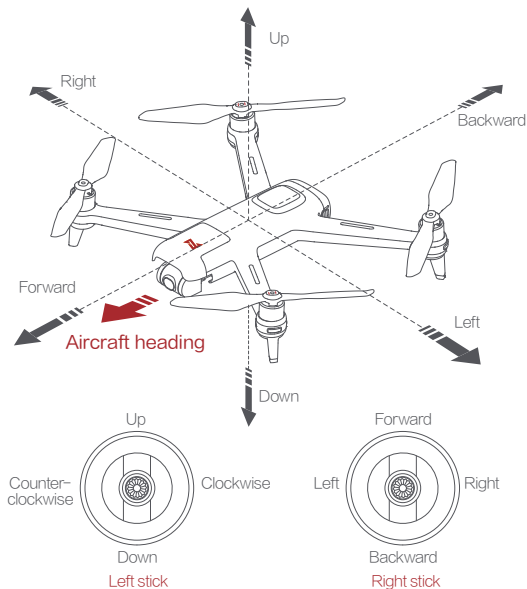

Note: The setting of the remote controller stick can be changed in the remote controller settings menu (the default is American hand).

2.3 Main menu of RC

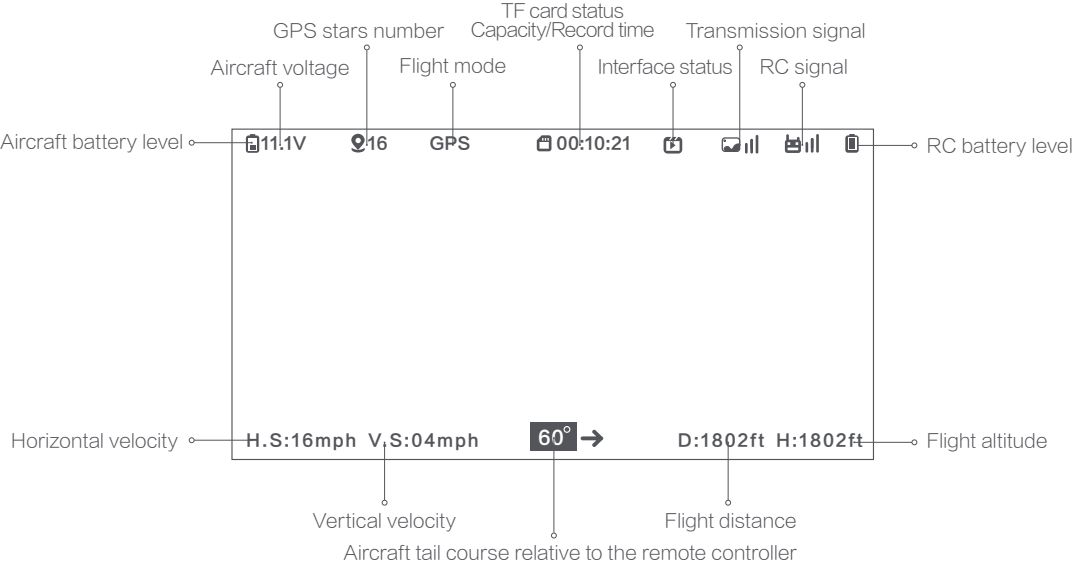

Aircraft

Flying mode

SPORT mode (sport)

GPS module is used to achieve precise hovering, and intelligent flight function is supported in SPORT mode. The maximum flight speed is 18m/s, the maximum rising speed is 6m/s, and the maximum descending speed is 5m/s.

GPS mode (standard)

GPS module is used to achieve precise hovering, and intelligent flight function is supported in GPS mode. The maximum flight speed is 10m/s, the maximum rising speed is 3m/s, and the maximum descending speed is 3m/s.

ATTI mode (posture)

The aircraft enters ATTI mode under the condition of poor GPS signal or compass interference. Under ATTI mode, the aircraft will drift in the horizontal direction and do not support the intelligent flight function. Therefore, in order to avoid an accident, users should choose a location with good GPS signal and open space to fly. Once the aircraft enters ATTI mode, please land to a safe position as soon as possible. Before take off and during flying, users can select to start ATTI mode from the menu of the remote control. When ATTI mode is turned on, the mode key can be turned to the left to enter ATTI mode, and the mode key can be turned to the right to switch to GPS mode.

Note: When there is no connection between the aircraft and the remote controller, the main interface will display N/A by default. After the connection is established, the main interface will display according to the current status of the aircraft.

The switching logic is as follows:

Mode	State	S	GPS
SPORT mode	Open	ATTI	GPS
ATTI mode	Open		
SPORT mode	Open	SPORT	GPS
ATTI mode	Close		
SPORT mode	Close	ATTI	GPS
ATTI mode	Open		
SPORT mode	Close	/	GPS
ATTI mode	Close		

Aircraft indicators recognition

	Aircraft indicator	Aircraft status
1	All lights breathing	Self-checking
2	All lights on	Aircraft on the ground: self-check fails
		Aircraft in the air: internal error
3	Two white lights on; Red and green lights flash at regular intervals	Ready to fly / Flying
4	Four lights flash twice	Low battery alerts
5	Four lights glaring	Battery is low, land as soon as possible
6	Two white lights flash	Aircraft firmware updating

Safety protection

Lost return

Lost return is only supported in GPS and SPORT mode. When the GPS signal is good, the compass is working normally and the aircraft records the return point successfully, if the wireless signal of the aircraft and the remote controller is interrupted for 3 seconds or more, the flight control system will take over the control of the aircraft and plan the return route according to the original flight path, and the aircraft will fly back to the return point. If the aircraft and the wireless remote controller signal is reconnected in the return process, users can short press the return key to cancel the lost return, and the aircraft will hover at the current position. If the user does not cancel the lost return, operating the stick can also control the aircraft, but when the user loosen the stick, the aircraft will continue its course of return until it gets back to the return point.

Low-power protection

In the flying process of the aircraft, when the battery power enters into the first level of low-power and it is only enough to complete the return, the remote controller screen prompts the user that the aircraft needs to return. If the user does not perform the return operation, then the aircraft will land automatically when the battery power enters into the second level of low-power, which is only enough to make the landing.

Hovering over the edge of a no-fly zone

The aircraft will automatically hover in the restricted flight area designated by the state, such as the edge of the airport, and the corresponding prompt of no-fly zone will appear on the remote controller screen. The user can use the stick to control the aircraft to evacuate the edge of the no-fly zone, but the stick cannot control the aircraft to fly into the no-fly zone.

Intelligent flying

One-key return

When the aircraft is flying in the air, the user can long press the "Return" button for more than 3 seconds to make the aircraft enter the automatic return. When the return distance of the aircraft is $D < 10$ meters, and if the flying height is $H < 3$ meters, the aircraft will rise to 3 meters and return to the take-off point for landing; if the flying height is $H \geq 3$ meters, the aircraft will directly return to the take-off point for landing at the original height. When the return distance of the aircraft is $D \geq 10$ meters, and if the flying height is $H < 30$ meters, the aircraft will rise to 30 meters and return to the take-off point for landing; if the flying height is $H \geq 30$ meters, the aircraft will directly return to the take-off point for landing at the original height. In the course of one-key return, you may exit one-key return by pressing the return key.

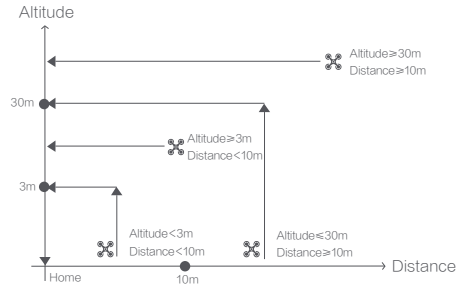

Self-timer flying

Before self-timer flying, please adjust the posture of the aircraft so that the target is in the middle of the picture. After adjusting the pitch angle of the cradle head, select self-timer flying in the menu of the remote controller. The aircraft will reverse along the pitch angle of the cradle head at a certain speed until the direct distance between the aircraft and the target reaches 150 meters or the flight height reaches 120 meters. At the end of the self-timer flying, the aircraft will automatically return to the starting point. In the process of self-timer flying, shortly press the "Return" button to exit the self-timer flying and the aircraft will automatically return to the starting point.

Following flying

Following flying is supported only in GPS mode and SPORT mode. Only when the aircraft and the remote controller have six satellites or more can it start following flying. If the condition is not met, the remote controller indicates that the current GPS signal is poor and the intelligent flying cannot be started. Users can choose the following flying in the remote controller menu and set the distance and height between the aircraft and people. The aircraft will take the remote controller as tracking target. Shortly press return key to exit following flying.

Note: During the following flying of the aircraft, users should always make sure to avoid people, animals and obstacles in the tracking path to ensure the safety of the flying. Users should comply with local laws and regulations when using the function of following flying.

Headless mode

The aircraft will take the current nose direction as the forward direction. During the flight, even if the nose direction of the aircraft changes, the forward direction will remain unchanged, so the user can adjust the shooting angle. Shortly press return key to exit headless mode.

Around-point flying

The user can select around-point flying on the remote controller menu. Before the around-point flying, please select the interest point first. After the selection, click the around-point flying to execute the command. Shortly press the return key to exit around-point flying.

Users can freely control the radius, height and speed of flying around point through the stick, as shown below.

Left stick	Push up	Increase the altitude of around-point flying
	Pull down	Reduce the altitude of around-point flying
Right stick	Push up	Increase the radius of around-point flying
	Pull down	Reduce the radius of around-point flying
	Turn left	Increase the speed of around-point flying
	Turn right	Reduce the speed of around-point flying

Note: When the aircraft's tail is pointed toward the remote controller, the left stick is adjusted to the same direction as the American hand. Therefore, the user should be careful when adjusting the course of around-point flying to avoid the backswing, which will result in flight accidents.

Fixed-wing mode

When the aircraft is flying in the air, the user clicks the fixed wing mode on the remote controller menu, and the aircraft will fly forward at a constant speed and cannot fly backward. Press the return key and exit the fixed wing mode.

Users can freely control the speed and route of the aircraft through the stick, and the specific functions are as follows.

Left stick	Push up	Climb up
	Pull down	Nose dive
	Turn left	Left turn
	Turn right	Right turn
Right stick	Push up	Speed up
	Pull down	Speed down
	Turn left	Left turn
	Turn right	Right turn

Note: In fixed wing mode, the aircraft cannot fall back, so when the operating stick decreases the speed to 0, the aircraft is hovering.

DIY

The fuselage is reserved with 6pin standard protocol interface (UartTX, UartRX, GPIO, PWM, VCC, GND), and the output voltage of the aircraft is 10v~12.6v. The remote controller is set with custom keys, through which users can do smoke trailing, air delivery and lamp hanging by DIY.

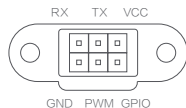

Installation and disassembly of aircraft TF card

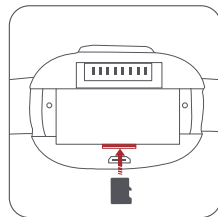

- When installing SD card to the aircraft, please remove the battery first.
- Insert the SD card with the literal upward into the SD card slot.
- When removing SD card, press the SD card to pop out.

Note: Users can export the aerial photography data through Micro USB interface.

Assembly & disassembly of propeller

- Attach propellers according to color mark on the motor axis.
- Align the propeller against the clamp of the motor shaft and ensure that the propeller is pressed to the root of the motor shaft.
- Rotate the propeller to the end in the direction of the lock mark, and the propeller will bounce and lock.
- Press the propeller forcefully and rotate the propeller along the opposite direction of the lock mark to remove the propeller.

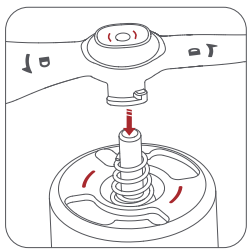

Note: Take the installation of reverse propeller as an example.

Safety tips:

- If the propeller is damaged, please replace the propeller to ensure flight safety and efficiency.
- Check that the propeller is properly installed and fastened before each flight.
- Stay away from the rotating propeller to avoid cutting.

Turning on and off the aircraft

- Short press + long press the power button until the aircraft indicator lights are on, meaning turned on.
- Short press + long press the power button until the aircraft indicator lights are off, meaning turned off.

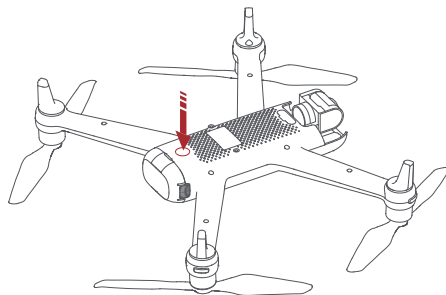

Battery

Charge aircraft battery

- Connect the battery, the balance charge and power adapter as shown below, and turn on the power supply.
- When charging, the red indicator on the left side of the balance charge is always on.
- After charging completed, the red indicator on the left side of the balance charge goes out.
- It takes about 2.5 hours to fully charge the battery.

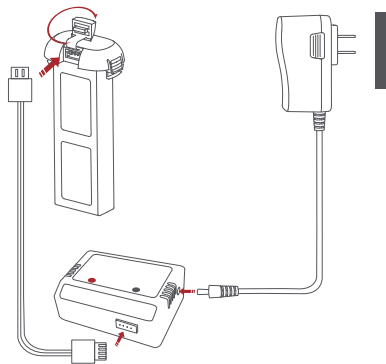

Safety tips: Please remove the battery from the aircraft and recharge it. Be sure to read carefully and strictly follow the instructions and disclaimers before charging. The user shall bear the consequences caused by the failure to use the product as required. Make sure the battery is fully charged before you use it for the first time.

Installation

- Push hard the battery, after the battery installed in place, there will be a "click" sound.
- To remove the battery, you need to press the battery buckle on both sides of the battery to pull out the battery.

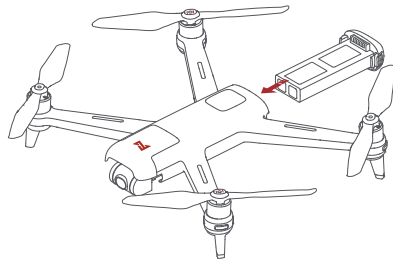

RC

With an built-in LCD display, simple menu for operation and ergonomic design, it can be operated and controlled easily and precisely. When the aircraft is started up, it can fly without tedious operation. The maximum remote operation time is about 4.5 hours.

1 Charging

- Connect the RC and power adapter as shown below.
- When charging, the battery icon on the main interface of RC flashes.
- After charging completed, the battery icon on the main interface of RC stops flashing.
- It takes about 3.5 hours to fully charge the RC.

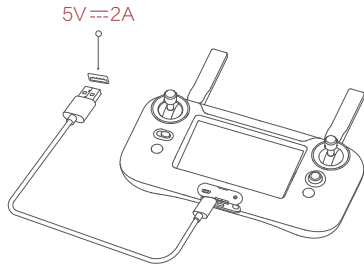

2 Turning on and off the RC

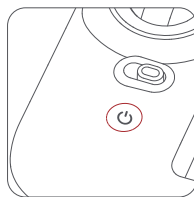

- Long press the power button to turn on / off the RC.

3 Installation and disassembly of remote TF card

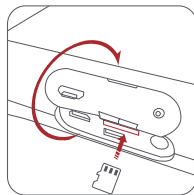

- When installing SD card to the RC, please remove the protection cover first.
- Insert the SD card with the literal downward into the SD card slot.
- When removing SD card, press the SD card to pop out.

4 AV - OUT interface

Users can connect the FPV glasses through the AV-OUT interface to experience the flight of the first perspective, or connect the monitor, etc., to view real-time image transmission.

Note: The reset hole can provide the hardware reset for the remote controller.



5 Shooting and Recording

- Short press the shoot / record button to take a picture.
- Long press the shoot / record button to start recording. Long press again to stop recording.
- During recording, short press the shoot / record button to capture a picture.
- The pitch angle of the gimbal can be controlled by toggling the left dial up and down.
- The right dial defaults to adjust EV.

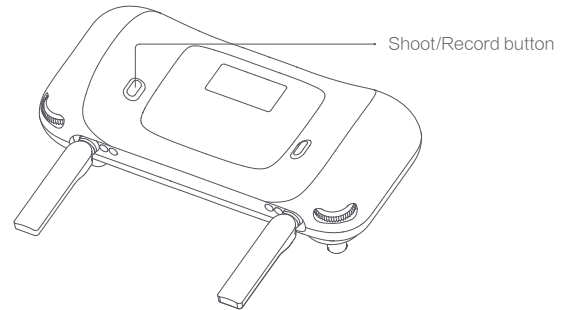

6 Quick action keys on the remote controller

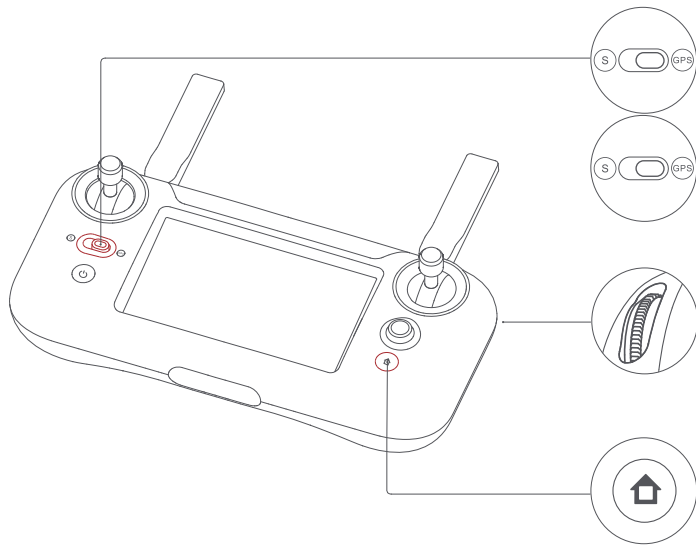

- When ATTI mode is turned on, the aircraft can be quickly switched to ATTI mode by switching the key to the left.
- When ATTI mode is turned off, the aircraft can be quickly switched to SPORT mode by switching the key to the left.
- The aircraft can be quickly switched to GPS mode by flicking the mode key to the right.
- The right dial is used to adjust EV value by default, and the custom set PWM is for DIY.
- The left dial can be moved up and down to adjust the pitch angle of the cradle head.
- When the aircraft is flying in the air, long press the "Return" key for more than 3 seconds, the aircraft will automatically return to the vicinity of the take-off point and automatically land.
- In the process of automatic return, short press the key of return, and the aircraft will enter the hovering state and wait for the instruction of the stick.
- The return key can exit intelligent flying with one key, and return to the main interface with one key when setting the menu.

7 RC settings

- Push the five-dimensional button to the right to access the media library.
- Toggle the five-dimensional button to the left to the settings menu.
- Toggle the five-directional button up and down to select the setting item, and press the center to enter the setting item.
- After setting completed, press the center to confirm. Toggle the five-directional button to the left to return to last level to set other items.
- Press the center key of the five-directional button key in the main interface to start/stop the remote controller screen recording.
- Toggle the five-directional button up to enter smart flight settings.
- Toggle the five-directional button down to enter camera parameters settings.

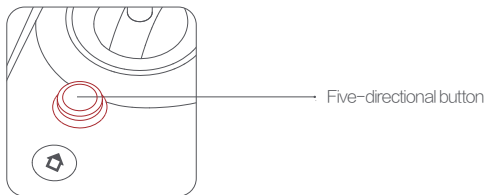

8 Remote controller code-matching

When a new remote controller or aircraft is replaced, the code-matching operation between the remote controller and the aircraft shall be performed again as follows:

- When the remote controller machine is turned on, the code-matching mode is entered through the menu of the remote controller screen, and the screen enters the code-matching interface.
- When the aircraft is turned on, long press the power key until the remote controller prompts the correct code-matching, and the remote controller makes a whining sound.

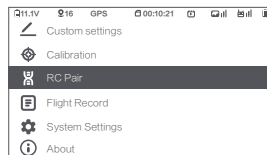

Long press the power button

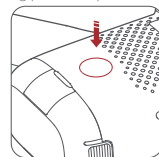

Flying

1 Inspection before flying

- Make sure that the battery of the aircraft and remote controller is sufficient.
- Make sure that the propeller is properly installed and free from damage and aging.
- Make sure that the camera lens is clean.
- Make sure that the TF card is inserted.

2 Confirm the aircraft heading

- The installation position of the aircraft battery is the tail direction.
- Once the aircraft is turned on, the heading can be told by navigation lights.
- Two white lights indicate the nose, and red & green lights indicate the tail.

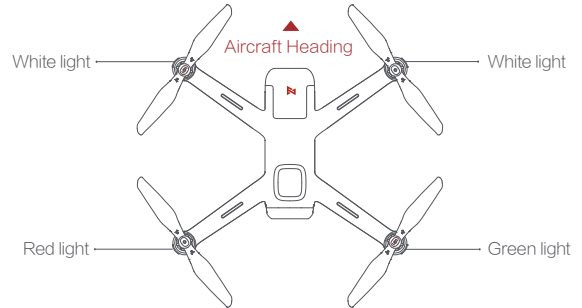

Safety tips: Always keep the tail pointed at the user to avoid direction misjudge.

3 Take off

- Keep both sticks to the bottom inner still over 1 second, the propellers start spinning.
- Release both sticks once propellers have been spinning, and firmly push the left stick upward to fly the aircraft.
- During flight, release both sticks to hover.
- At any time during controlled flight, release the two levers of the remote controller and the aircraft will hover automatically.

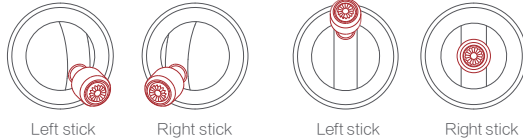

Safety tips: Push the left stick up firmly. The aircraft may roll over if you push too slowly.

4 Landing

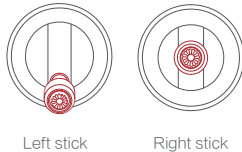

- Slowly pull down the left stick to land the aircraft.
- Once the aircraft has landed, push and hold the left stick down over 5 seconds, the motor will stop.

Safety tips: The aircraft has no waterproof function. Do not land on the sea. Do not land on an inclined plane for safety.

5 Automatic take-off/landing

- When taking off/landing automatically, the location with good GPS signal should be selected and kept away from people, animals, tall buildings and trees. Please land on an appropriate and safe place.
- Select auto takeoff in the remote controller menu. After take-off, the aircraft will hover 4 meters above the ground, waiting for the stick command.
- Select auto landing in the remote controller menu and then the aircraft will automatically land. The motor will be turned off automatically when the aircraft has landed on the ground. During the landing of the aircraft, the user can short-press the return button to cancel the automatic landing, and the aircraft will hover in the air, waiting for the stick command.

6 Emergency stop of propeller

When motors can't properly turn off, please toggle the left stick to the bottom inner in maximum range, and tap return button of RC for 5 seconds simultaneously, the motors will stop.

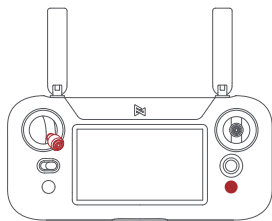

Safety tips: Do not do the above operation during normal flight to avoid falling accidentally.

7 Flight safety

- The aircraft is suitable for people above 18 years who have full civil capacity.
- Make sure to keep some distance from people, animals, trees, vehicles and buildings while using the aircraft. Please be careful when someone approaches.
- Keep away from airports, railways, highways, high-rise buildings, utility poles and other dangerous environments when operating the aircraft.
- Keep away from the areas with complex electromagnetic signals such as communication base stations and high-power antennas when operating the aircraft.
- The flight altitude and distance of the aircraft corresponding to the takeoff point will be limited based on relevant regulations and policies.
- Do not use this product at the place and time prohibited by regulations and policies.
- To protect the legitimate rights and interests of users, please follow the product safety instructions when using.
- Do not operate the aircraft in bad weather such as strong winds, rain, snow, or fog.
- Please operate the aircraft in a broad place with a good GPS signal.
- It is suggested that user should make the first flight under the guidance of an experienced user.

Calibration

1 Remote controller calibration

- Select "RC Calibration" in the remote controller setup menu.
- Click [OK] to start remote calibration.
- Push the two sticks to the maximum extent in the four directions as shown in the figure until the calibration is complete.
- Move the left dial to the upper and lower directions as shown in the figure to the maximum extent until the calibration is completed.

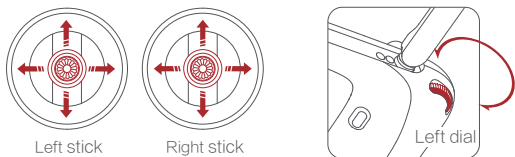

Note: When the remote controller is calibrated, please turn off the power of the aircraft.

2 Gimbal calibration

- Click Gimbal Calibration and enter the calibration page in the remote controller setup menu.
- After the aircraft is placed smoothly, click to start calibration. Don't move the aircraft during the calibration process.
- After the calibration is completed, the remote controller interface shows successful calibration.
- If the remote controller interface shows unsuccessful calibration, please retry it.

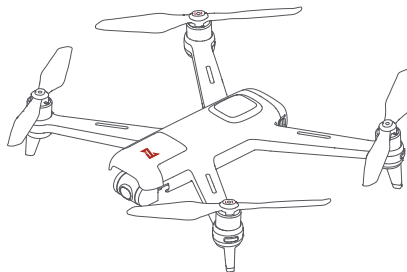

3 Compass calibration

If the magnetic field changes, the compass needs to be recalibrated to ensure flight safety. If the aircraft's compass needs to be calibrated, the remote controller will give a prompt.

- After entering the remote controller menu, please select compass calibration, and then calibrate based on prompts on the screen.
- If the green indicator of the aircraft flashes in pairs, please turn the aircraft horizontally according to the figure.
- If the red indicator of the aircraft flashes in pairs, please turn the aircraft vertically according to the figure.
- Successful calibration: The remote controller screen shows successful calibration, and the aircraft indicator returns to the status indication in the current mode.
- Unsuccessful calibration: The remote controller screen shows unsuccessful calibration. Please return to the menu to reselect compass calibration.

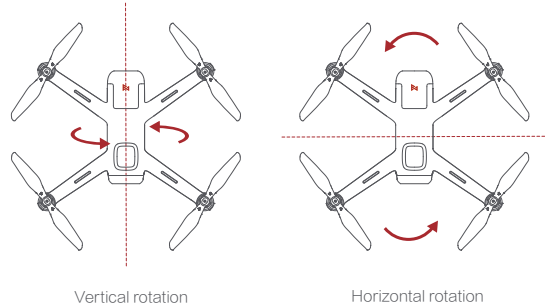

Maintenance

Propeller maintenance

The propeller is a wear part. When the propeller wears out, it needs to be replaced in time; otherwise, the aircraft cannot be operated normally.

Battery maintenance

Don't throw the battery into a fire. Don't bump the battery violently. In low temperature environments, the capacity of lithium batteries will be greatly reduced. Please don't use it below -5°C . Don't expose the battery to direct sunlight. Please refer to the Disclaimer and Safe Operation Guidelines when using the battery.

Gimbal maintenance

The A3's gimbal is all-in-one, no need to disassemble. Please be careful not to scratch the camera when receiving the aircraft. Please pay attention to the camera cleaning.

Aircraft self-test

The aircraft enters the self-test each time it is powered on. If the self-test fails, a remote will be received on the remote controller screen.

Firmware Upgrade

- Please check the firmware version number regularly and visit www.a3.fimi.com to download the new firmware.
- Remote controller upgrade:
Copy the remote controller firmware to the TF card, and then insert the TF card into the remote controller. Afterwards, turn on the power of the remote controller, and the remote controller enters the firmware upgrade state. At this time, the remote controller is inoperable. After the upgrade is successful, the remote controller automatically restarts and resumes operation.
- Flight control, no-fly zone, camera upgrade:
First insert the TF card into the aircraft and install the battery to turn it on. Connect your computer to the aircraft with the USB interface. Copy the downloaded firmware as follows:
Flight control version / No-fly zone version---UPGRADE
Camera version---TF card
Manually restart the aircraft power after the copy is completed. The aircraft enters the firmware upgrade state, and the two white indicators of the head flash. After the upgrade is successful, the aircraft automatically restarts.

Basic Specification

Aircraft

Product model: FMWRJ01A3
Dimensions: 285 x 229 x 69mm
Diagonal size: 323mm
Takeoff weight: About 560g
Flight time: About 25min*
Max ascending speed: 6m/s
Max descending speed: 5m/s
Max cruising speed: 18m/s
Max Transmission Distance: About 1000m*
Satellite positioning systems: GPS/GLONASS
Hover accuracy: ± 0.5 m (Vertical) , ± 1.5 m (Horizontal)
Operating temperature: 0 ~ 40° C
Suitable altitude: ≤ 5000 m
Memory card type: Micro SD (Class10 above) 8 ~ 64GB
Operating frequency: 2.4-2.483GHz; 5.725-5.850GHz

Power adapter

Rated input: 100-240V ~ 50/60Hz 0.3A
Rated output: 14V \equiv 0.8A
Rated power: 11.2W
Charging ambient temperature: 0° C ~ 40° C

Remote controller

Net weight: About 331g
Screen resolution: 480 x 272
Operating frequency: 2.4-2.483GHz; 5.725-5.850GHz
Type: Rechargeable lithium battery
Capacity: 2950mAh
Input: 5V \equiv 2A
Memory card type: Micro SD (the maximum support 32GB)
Operating temperature: 0 ~ 40° C
Suitable altitude: ≤ 5000 m

Battery

Type: Rechargeable lithium battery
Weight: About 162g
Capacity: 2000mAh
Voltage: 11.1V
Limit voltage: 12.75V
Energy: 22.2Wh
Charging ambient temperature: 0° C ~ 40° C

Gimbal

Controllable rotation range: 0° ~ -90° (Pitch)
Control angle accuracy: $\pm 0.02^\circ$
Lens: FOV80°
Camera aperture: f2.0
Camera focal distance: 3.54mm
Equivalent focal distance: 27mm
Sensor: 1/3.2" CMOS
Effective pixels: 8.08M
ISO range: 100 - 3200 (Video) , 100 - 1600 (Photo)
Shutter speed: 4 ~ 1/8000s
Max video resolution: 1920 x 1080 | 30fps
1920 x 1080 | 25fps
Max photo resolution: 3264 x 2448
File system: FAT32 / exFAT
Image format: JPG
Video format: MP4

Balance charge

Rated input: 14V \equiv 0.8A
Rated output: 11.1V \equiv 0.8A

Remarks:

The 25 minutes flight time refer to the constant speed flight time when single battery cell voltage at 4.35v and with gentle breeze. Please use charger supported 4.35V. Remote control distance reach to 1km (FCC) in open and no electro-magnetic interference area. All above testing and data are come from FIMI laboratory, errors may occur in actual use according to operating environmental changes.

